



ISTOBAL M'NEX
Simply brilliant

ISTOBAL
Vehicle Wash & Care

THE CAR WASH WORLD'S NEW EXPERIENCE

The ISTOBAL M'NEX rollovers will exceed all your expectations. The elegant modular design of this new series sets a new trend while meeting all your automatic vehicle wash needs.

Discover all the advantages that the different ISTOBAL M'NEX rollovers offer.

The most brilliant generation has arrived.

M'NEX

MUCH MORE

The new generation of rollovers stands out in so many ways: looks, mechanics, flexibility, and versatility. It has been created to satisfy the needs of the most demanding professionals in the car wash world.

What's more, this new series has a special quality which makes it different to anything the market has ever known before: its adaptability.

The interior immediately appeals with its stylish modern design, which combines the latest technology and maximum reliability in the wash.



► MORE EFFICIENT

Brush and horizontal dryer lift

Our new system features 2 separate groups of lifting motors with KEVLAR® fibre reinforced flat belts eliminating counterweights.

Mounted on top of the column, the lifting system is easily accesible and virtually maintenance free.

Speed and position control via frequency converters and encoders

These components allow greater control of the horizontal brush and dryer, getting wash and dry times down by optimising the speed of displacement.

► MORE FLEXIBLE

Program configurator

The new generation system of flexible programming incorporated into the ISTOBAL M'NEX rollovers means each wash program can be personalised and created from scratch.

In addition, you can comfortably configure speeds, dispensers, lighting codes and other functions according to the requirements of the wash programs you choose.

► MORE VERSATILE

High-pressure

New top high-pressure system without scanner and with zero angle nozzles. The possibility of applying oscillating and side high-pressure on the same pass.

Quicker because no vehicle scanning is needed.

Fewer problems caused by dripping because it is not directly above the vehicle.



ISTOBAL
M'NEX22



▶ ROOMIER

New height and width combinations on each model, which means the needs of all vehicles currently on the market are covered.

Greater standard wash width of 2.50 m at the mirror height.

Width of 2.70 m also available.

▶ MORE RELIABLE

Wheel-wash

Smoother operation thanks to a new chassis with 3 antivibration points.

New high pressure hydraulic rotary joint

A more effective design with rotating unions which are completely sealed and low friction guide system, resistant to dirt and rust.

Photocells

New generation photocells specially designed for use on rollovers. Greater accuracy and reliability.

▶ MORE MODERN

Front fairing

New updated image: a design fully in tune with the latest trends in the automobile sector. Lights with LED technology guaranteeing lower consumption and longer life.

Rear fairing

The rear fairing is integrated into the structure design of the machines to improve the overall look.



► GREATER TILT

New pneumatic system

Total control over the two tilt positions of the side brushes.

Greater wash accuracy where the side meets the roof of the vehicle.

Greater brush stability during the wash.

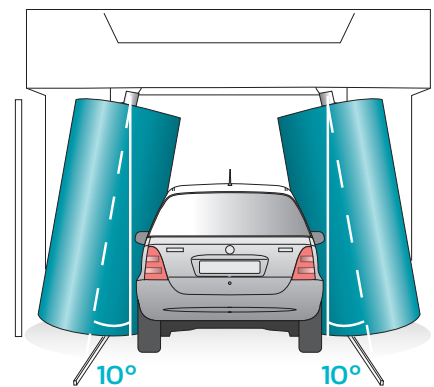

► MORE COMPACT

Columns

Up to 4 side pipes totally embedded in the column.

The vehicle is thus free to pass through with no risk of protruding parts coming into contact with the wing mirrors. The fairing over the various parts and pipes, which are totally integrated totally into the columns, gives the machine a much more appealing look.

Aluminium guides artfully concealed in the column keep the brushes and horizontal dryer on track.



▶ BETTER PERFORMANCE

Horizontal and side dryer

New dryer nozzle design which maximises performance and minimises consumption (1500rpm motors) and noise (71.1 dB with 12 kW).

Available dryer power:

- 2 x 3 kW on side dryers
- 2 x 3 kW / 2 x 4 kW on horizontal dryer

New diffuser with 3 positions

Improved quality on the horizontal dryer, specially on the front and back of the vehicle.

New side dryer

The design of the nozzles has been optimised to channel the maximum air flow towards the rocker panel to draw off the maximum amount of water.

▶ MORE TECHNOLOGY

Control CPU

CPU with unified modules and more flexible configuration possibilities for optional extras. Includes Profibus communication protocol: communication is easier. Wiring, cables and connections are kept to a minimum. Bigger memory.

Command post

Connects and controls all the external machine optional extras.

Two viewing options: standard and colour touch-screen.



▶ MORE SAFETY

Includes as standard a wide range of multisystem safety features to guarantee a safe wash facility.

Many optional safety features are also available to meet the more specific needs of each customer: vehicle derailing prevention system, exterior anti-smashing system and safe height limit.

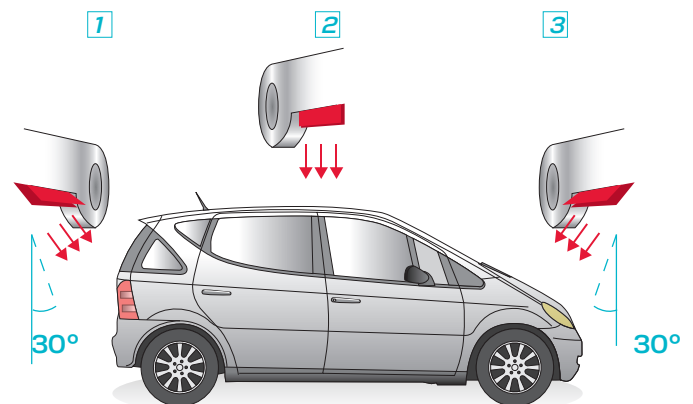

TECHNICAL DATA – 22

GENERAL FEATURES OF THE ISTOBAL M'NEX

- ▶ Rollover structure made of hot-dip galvanised steel with a minimum thickness of 50 micras.
- ▶ Service lines connected by energy chain.
- ▶ 4-nozzle wax circuit and shampoo circuit with pneumatic dosing pumps specific to each circuit.
- ▶ Electronic circuits set up for connection to self-service.
- ▶ Hydraulic circuit can work with two different types of water.
- ▶ Non-drip system.

ISTOBAL M'NEX22

- ▶ Wash and dry rollover comprising 2 vertical brushes and 1 horizontal brush controlled by power transducers.
- ▶ Option to include different dryer combinations on the same rollover.
- ▶ Optional structure powder coating with a minimum thickness of 60 micras (30 primer, 30 colour).

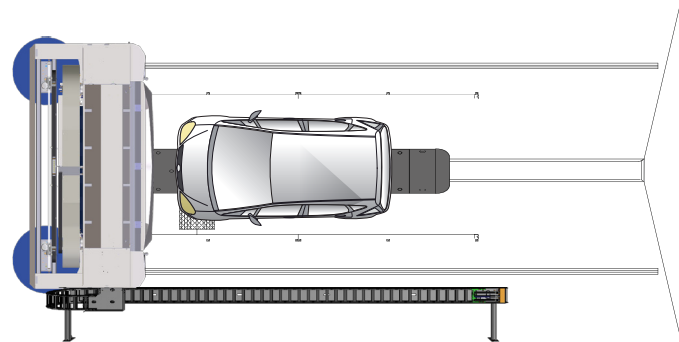

WASH DIMENSIONS

MAX. VEHICLE HEIGHT	2100	2300		2500		2700		2900		
VEHICLE ACCESS WIDTH	2500	2500	2700	2500	2700	2500		2700	2700	
LENGTH OF RAILS	9000	9000	9000	9000	9000	10000	11000	10000	11000	11000
MINIMUM MACHINE WIDTH*	4058	4058	4258	4058	4258	4058	4058	4258	4258	4258
MAXIMUM MACHINE WIDTH**	4312	4312	4512	4312	4512	4312	4312	4512	4512	4512
TOTAL MACHINE HEIGHT	2900	3100	3100	3300	3300	3500	3500	3500	3500	3700

* Includes energy chain

**Includes energy chain + optional anti-splash screens

All measurements in mm.

COLOUR SAMPLES M'NEX

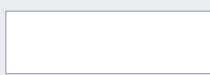

RAL 9016

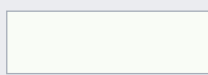

RAL 9010

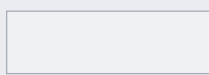

PANTONE®Cool Gray 1C

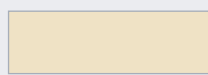

RAL 1013

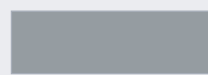

RAL 7042

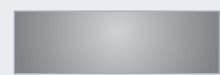

RAL 9006

ISTOBAL

M'NEX22

MAXIMUM EFFICIENCY & VERSATILITY



FOAMY CHEMICAL SPRAY

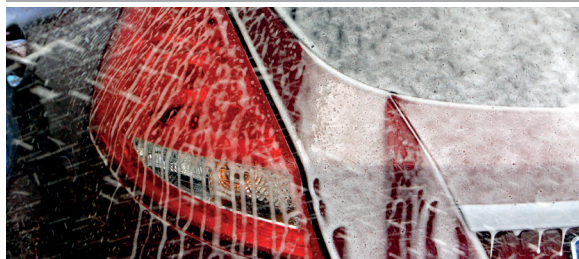

A pneumatic pump with an extra high-flow rate powerfully applies a chemical product specially formulated for removing mosquitos and stubborn dirt to ensure an exceptional finish.

Other chemical sprays available:

- Chemical spray for the rocker panel
- Chemical spray for mosquitos
- Chemical spray hot or cold
- Chemical spray for Scandinavia

DISC WHEEL-WASH WITH HIGH-PRES-SURE



The new rotating 80 bar high-pressure fitted to the wheel-wash means that the rims can be worked on more thoroughly as indeed can the whole vehicle itself. Its dual action spin gives better results on new wheel rim designs.

Other wheel washes available:

- Telescopic wheel washes
- High pressure wheel washes with 6 rotating nozzles.

* Optional extras available for the complete ISTOBAL M'NEX series.

* For other colours please check the ISTOBAL available colour

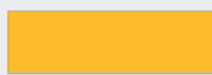

RAL 1021



RAL 2004

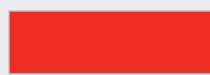

RAL 3020



PANTONE® 348 C

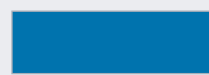

RAL 5015

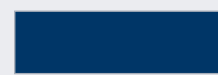

RAL 5003

TECHNICAL DATA – 25

ISTOBAL M'NEX25

- ▶ Two synchronized rollovers (dry -wash) working on one single 11 m bay and giving truly surprising results.
- ▶ High-flow drying at low revolutions (1500 rpm) and 14 kW of power.
- ▶ Double service lines connected by energy chain.
- ▶ Powder coating with a minimum thickness of 60 micras (30 primer, 30 colour).
- ▶ Maximum flexibility: optional extras can be added to both modules-dry and wash - thus optimizing each pass.

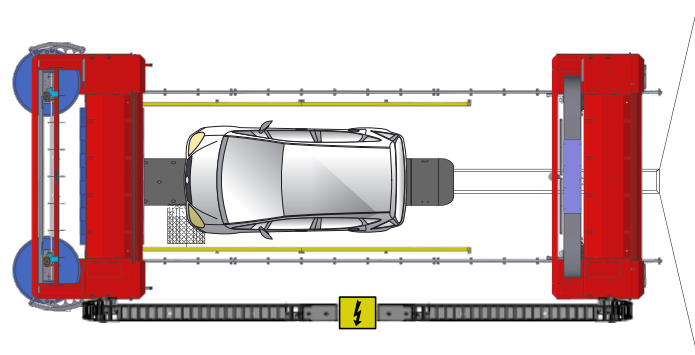

WASH DIMENSIONS

MAX. VEHICLE HEIGHT	2300	2500				2700	
VEHICLE ACCESS WIDTH	2500	2500	2700		2500	2700	
LENGTH OF RAILS	11000	11000	12000	11000	12000	12000	12000
MINIMUM MACHINE WIDTH*	4058	4058	4058	4258	4258	4058	4258
MAXIMUM MACHINE WIDTH**	4312	4312	4312	4512	4512	4312	4512
TOTAL MACHINE HEIGHT	3100	3300	3300	3300	3300	3500	3500

* Includes energy chain

** Includes energy chain + optional anti-splash screens

All measurements in mm.

COLOUR SAMPLES ISTOBAL M'NEX

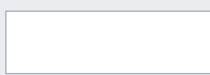

RAL 9016



RAL 9010

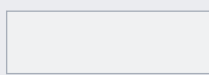

PANTONE®Cool Gray 1C

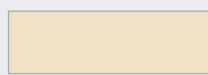

RAL 1013

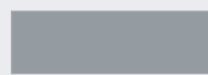

RAL 7042

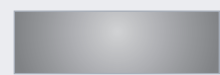

RAL 9006

ISTOBAL

M'NEX25

TWOGETHER TO WIN



HORIZONTAL HIGH-PRESSURE



Fitted to the wash module, its smooth accurate operation combined with 14 rotating nozzles means every last corner of the vehicle is treated to a thorough high-pressure wash.

Other high pressures are available in levels ranging from 15 to 160 bar:

- High-pressure sides fixed-position
- High-pressure sides oscillating
- High-pressure for rocker panel

* Optional extra available only for ISTOBAL M'NEX25.

WHEEL-WASH WITH HIGH-PRESSURE



6 rotating nozzles give a top quality rim wash. The ideal companion to the new horizontal high pressure.

On top of this, the flexible configuration possibilities of this new series means different wheel washes can be fitted to both modules of the ISTOBAL M'NEX25.

* Optional extra available for the complete ISTOBAL M'NEX series.

* For other colours please check availability.



RAL 1021



RAL 2004



RAL 3020

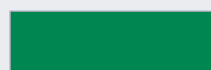

PANTONE® 348 C

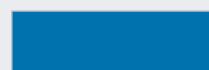

RAL 5015

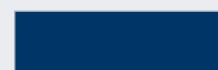

RAL 5003

TECHNICAL DATA – 27

ISTOBAL M'NEX27

- ▶ Two rollovers working on two separate bays (wet bay and dry bay) making for a considerable increase in throughput.
- ▶ Total absence of dripping during the drying phase since the water appliances are on a separate wet bay.
- ▶ Double service lines connected by energy chain.
- ▶ Powder coating with a minimum thickness of 60 micras (30 primer, 30 colour)
- ▶ High-flow drying at low revolutions (1500 rpm) and 14 kW of power.
- ▶ Each module can be individually personalized.

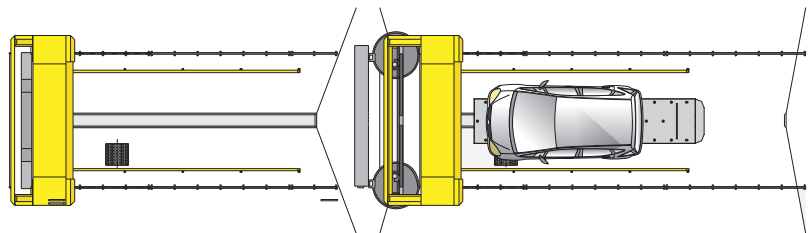

WASH DIMENSIONS

MAX. VEHICLE HEIGHT	2300	2700
VEHICLE ACCESS WIDTH	2500	2500
RAIL LENGTH WASH	9000	10000
RAIL LENGTH DRY	7000	8000
MINIMUM MACHINE WIDTH*	4058	4058
MAXIMUM MACHINE WIDTH**	4312	4312
TOTAL MACHINE HEIGHT	3100	3500

* Includes energy chain

** Includes energy chain + optional anti-splash screens

All measurements in mm.

COLOUR SAMPLES ISTOBAL M'NEX

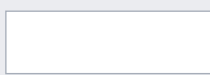

RAL 9016



RAL 9010

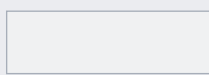

PANTONE®Cool Gray 1C

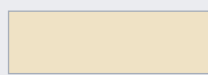

RAL 1013

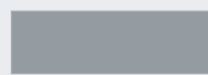

RAL 7042

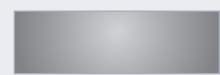

RAL 9006

ISTOBAL

M'NEX27

DOUBLE THE EFFICIENCY DOUBLE THE PROFIT



HIGH-SHINE FOAMY WAX



The special wax bath followed by an effective massage by the brushes gives an incomparable shine and protects the paintwork of the vehicle from the daily attacks of elements in the air.

Other waxes available:

- Super wax
- Foamy wax
- Hot wax

* Optional extras available for the whole ISTOBAL M'NEX series.

TRIPLE FOAM



Catch your customers attention with an explosion of colour as the machine works to improve the quality of the wash while looking after the paintwork of the vehicles.

Other foams available:

- Standard active foam
- Super active foam
- Hot active foam

* For other colours please check availability.



RAL 1021



RAL 2004



RAL 3020

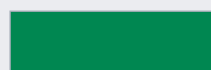

PANTONE® 348 C

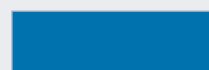

RAL 5015

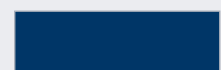

RAL 5003

TECHNICAL DATA – 28

ISTOBAL M'NEX28

- ▶ Wash and dry rollover comprising 4 vertical brushes and 1 horizontal brush controlled by power transducers.
- ▶ Powder coating with a minimum thickness of 60 micras (30 primer, 30 colour).
- ▶ A machine with enormous potential: complete wash and dry programs carried out efficiently in the minimum time.
- ▶ Its compact design means it can be used as a replacement on facilities already existing with no need for building work since it can be installed on a standard 9-metre bay.

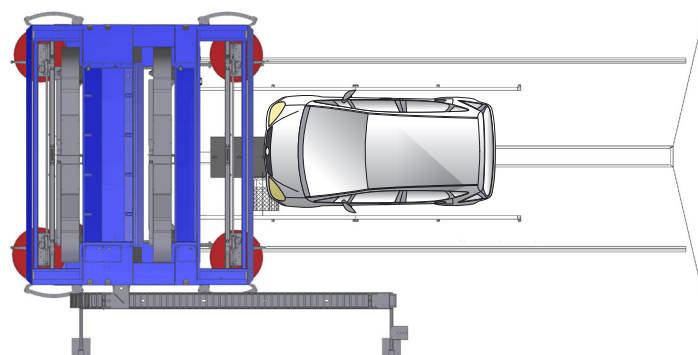

WASH DIMENSIONS

MAX. VEHICLE HEIGHT	2300						2700			
VEHICLE ACCESS WIDTH	2500			2700			2500		2700	
LENGTH OF RAILS	9000	10000	11000	9000	10000	11000	10000	11000	10000	11000
MINIMUM MACHINE WIDTH*	4058	4058	4058	4258	4258	4258	4058	4058	4258	4258
MAXIMUM MACHINE WIDTH**	4312	4312	4312	4512	4512	4512	4312	4312	4512	4512
TOTAL MACHINE HEIGHT	3100	3100	3100	3100	3100	3100	3500	3500	3500	3500

* Includes energy chain

** Includes energy chain + optional anti-splash screens

All measurements in mm.

COLOUR SAMPLES ISTOBAL M'NEX

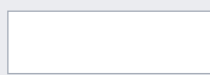

RAL 9016



RAL 9010

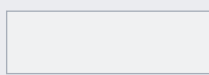

PANTONE® Cool Gray 1C

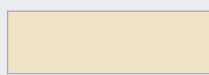

RAL 1013

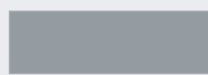

RAL 7042

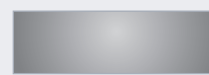

RAL 9006

ISTOBAL

M'NEX28

MAXIMUM OUTPUT MINIMUM SPACE



XTRA FAIRING + STAR CLASS



Fairing designed exclusively for the ISTOBAL M'NEX28 to incorporate SFERIC lighting and a choice of either STUDIO or STAR CLASS pictograms.

* Optional extras available only for ISTOBAL M'NEX28.

DOUBLE SCAN DRYER



The only rollover in the ISTOBAL M'NEX series which offers two 8 kW horizontal dryers working simultaneously.

* For other colours please check availability.



RAL 1021



RAL 2004



RAL 3020



PANTONE® 348 C

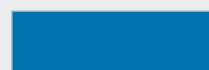

RAL 5015

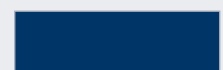

RAL 5003

MORE IMAGE

ZENIT FAIRING



The ISTOBAL MNEX sleek cover design matches its technological capabilities. Its modern design includes supplements for the different machine heights.

BOOMERANG LIGHTING

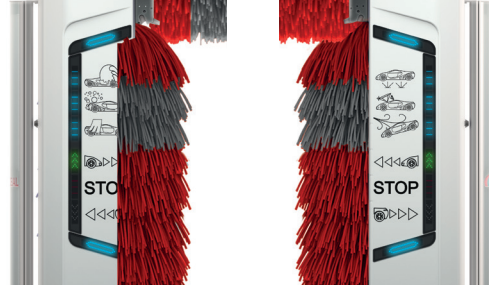

The most spectacular modern lighting, which features the latest LED technology. Developed exclusively to reinforce the ultra modern look of the ZENIT fairing.

CUBIK FAIRING



Smooth, straight lines for a functional fairing. Available in sides only or central front fairing versions.

LINEAR LIGHTING



Lighting with wash phase indicators, integrated traffic light and positioning (only for ZENIT fairing).

ANTI-SPLASH SCREENS



A modern, practical design which can incorporate any of the external safety options your facility may need in a visually appealing way.

SFERIC LIGHTING

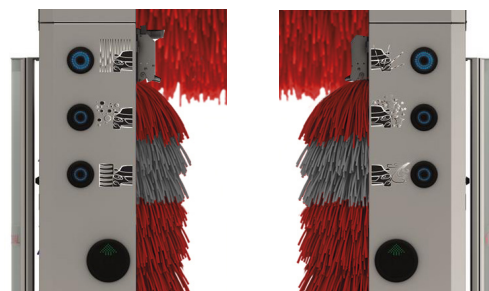

Wash phase indicator lights, with traffic light or designer positioning to blend in stylishly with your CUBIK or ZENIT fairing.

MORE FEATURES

CHEMICAL SPRAYS

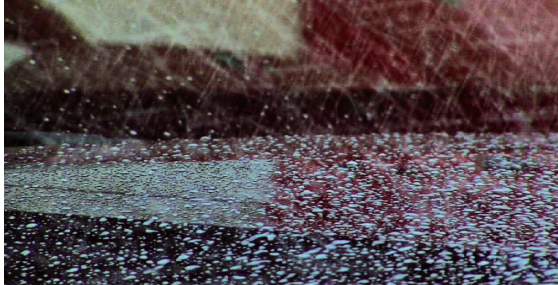

The ideal accessory for increasing profits on your wash facility. Dosing pump equipped with VITON® membranes offering greater resistance to aggressive chemical products.

UNDERCHASSIS WASH



The perfect optional extra for the best all-round wash for your most demanding customers. You can choose from: fixed underchassis wash 10 bar, 90 L/min., oscillating underchassis wash 15 bar, 120 L/min. or underchassis wash by sectors 15 bar, 120 L/min.

DRYERS



Get an optimum quality dry with the new high-flow side dryers comprising two independent motors at 1500 rpm and 3 kW of power.

HIGH-PRESSURE



Various high pressure prewash options which prepare the vehicle for the brush wash and thus improve the results. Choose from versions: 15 bar and 120 L/min., 80 bar and 42 L/min. or 80 bar and 84 L/min.

IW MANAGER



New software developed for integrated control of all the units in your wash either for local or remote setup.

COLOUR TOUCH-SCREEN



New generation colour touch-screen on a functional command post making it easier to connect and control all the optional extras on your car wash machine.

The first brush fitting system without limits for car wash machines.

ISTOBAL has obtained the official patent for the new **link-it**[®] system, which guarantees that it is the first and only brush fitting system on the market to combine a series of features unheard of before, bringing unprecedented advantages for our customers. Advantages such as flexibility, profitability, durability, versatility, and respect for the environment.

The support sections of the **link-it**[®] brush fitting system can be reused as many times as needed; you only need to change and dispose of the worn brush wash materials. In fact, the life cycle of the support is superior to that of the vehicle wash machine itself.

- *Multiple combinations of wash materials.*
- *Maximum profit.*
- *50% less waste material when the brushes are changed.*
- *Quick, easy and economical maintenance.*
- *Maximum respect for the environment.*
- *Maximum versatility in colours and space-saving combinations.*

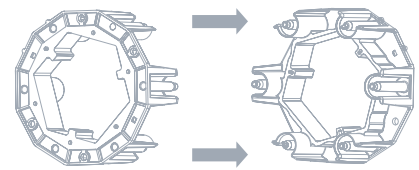

G
GALERÍA DE INNOVACIÓN
2011

mortec
automechanika
IBÉRICA

GEWINNER-
PRODUKT



Mountable in 6 easy steps

It's as easy as separating the two halves of the **link-it**[®] holder, choosing the segments of the wash material and the colours most suited to your needs and tastes, and closing the two halves again.



NOTE: ISTOBAL, S.A. reserves the right to introduce modifications designed to improve its products.



ISTOBAL
M'NEX22

STOP

